

JVC

COLOUR TELEVISION

AV-32WFX1EU

AV-28WFX1EU

Instructions

Thank you for buying this JVC colour television. To make sure you understand how to use your new TV, please read this manual thoroughly before you begin.

WARNING:

TO PREVENT FIRE OR SHOCK HAZARD, DO NOT EXPOSE THIS APPLIANCE TO RAIN OR MOISTURE.

CAUTION:

TO ENSURE PERSONAL SAFETY, OBSERVE THE FOLLOWING RULES REGARDING THE USE OF THIS UNIT.

1. Operate only from the power source specified (AC 220 – 240 V, 50 Hz) on the unit.
2. Avoid damaging the AC plug and power cord.
3. Avoid improper installation and never position the unit where good ventilation is unattainable. When installing this television, distance recommendations must be maintained between the floor and wall, as well as instalment in a tightly enclosed area or piece of furniture. Adhere to the minimum distance guidelines shown for safe operation.

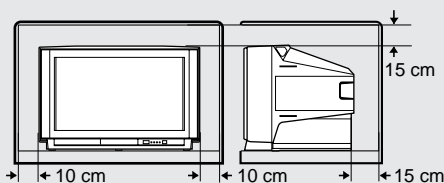

4. Do not allow objects or liquid into the cabinet openings.
5. In the event of a fault, unplug the unit and call a service technician. Do not attempt to repair it yourself or remove the rear cover.
6. For AV-32WFX1EU only:
The surface of the TV screen is coated with a thin film which can easily be damaged. Be very careful with it when handling the TV.
Should the TV screen become soiled, wipe it with a soft dry cloth. Never rub it forcefully. Never use any cleaner or detergent on it.

When you don't use this TV set for a long period of time, be sure to disconnect the power plug from the AC socket.

InteriArt

Natural Vision

T-V LINK

CONTENTS

Preparation	2
T-V LINK Functions	5
Basic Operation	6
Remote Control Buttons and Functions	8
Menu Operation	14
Picture Setting	15
Picture Features	16
Sound Setting	18
EXT Setting	20
Features	21
Install	23
Index	27
Demo	27
Additional Preparation	28
Connecting an Audio System	29
Channel Table	30
TV Buttons and Parts	31
Troubleshooting	32
Specifications	34

Preparation

1 Connecting the Aerial and VCR

If connecting a VCR, follow (A) → (B) → (C) → (D).
If not connecting a VCR, follow ① → ②.

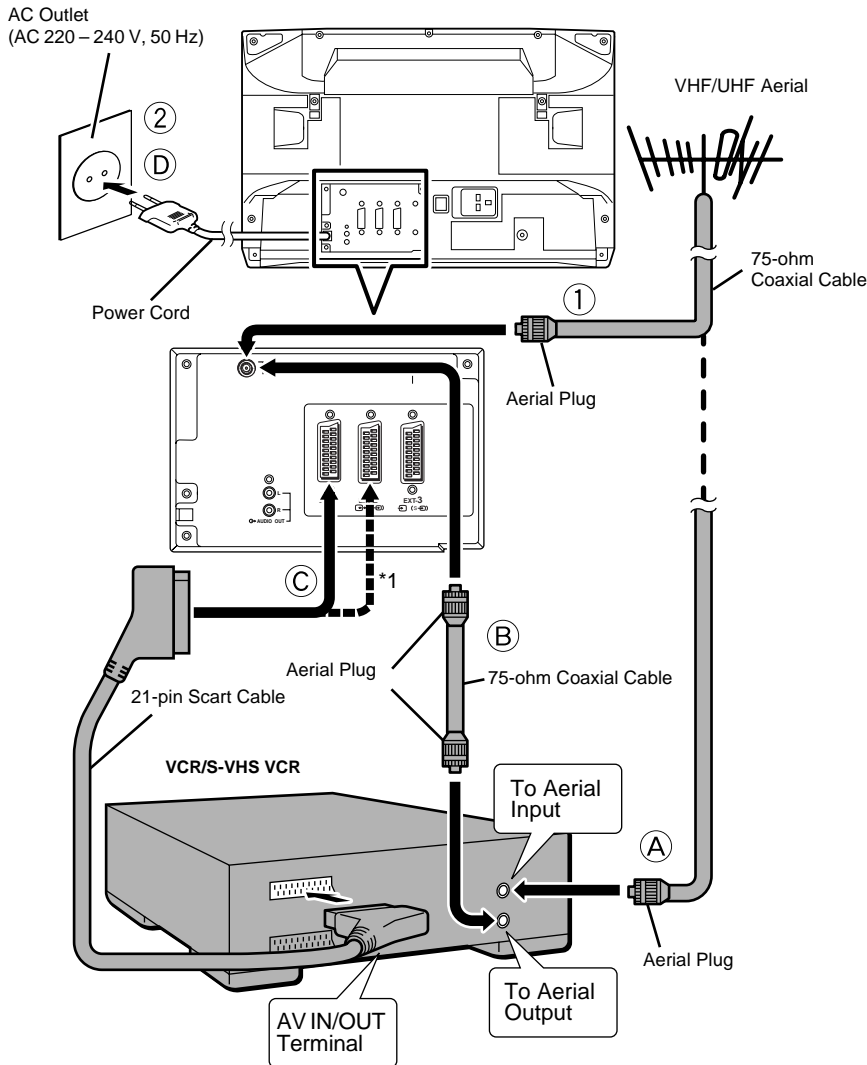

Notes:

- For further details, refer to the manuals provided with the devices to be connected.
- The connecting cables are not provided.
- A video can be viewed from the VCR without performing (C). For details, refer to the VCR manual.
- The ■ shaded items are not provided.
- To connect additional external devices, please refer to page 28.
- To connect an audio system, please refer to page 29.

*1 This TV is T-V LINK compatible. To operate T-V LINK, a T-V LINK compatible VCR must be connected to the EXT-2 Terminal on the TV.

Notes:

- For details about T-V LINK, refer to page 5.
- When a decoder is connected to a T-V LINK compatible VCR, set the Decoder (EXT-2) in the Features menu to ON. (See "Decoder (EXT-2)" on page 22.) Otherwise, you will not be able to view scrambled channels.

2 Putting Batteries into the Remote Control

Use two AAA/R03 dry cell batteries.
Insert the batteries from the ⊖ end, making sure the ⊕ and ⊖ polarities are correct.

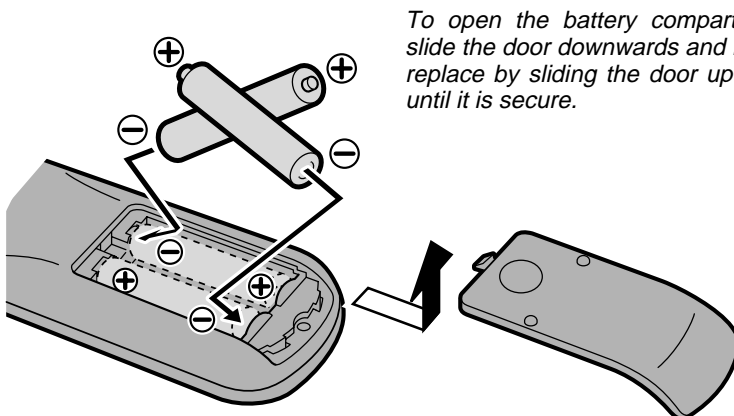

To open the battery compartment, slide the door downwards and lift off, replace by sliding the door upwards until it is secure.

Notes:

- Follow the warnings printed on the batteries.
- Battery life is about six months to one year, depending on frequency of use.
- If the remote control doesn't work properly, replace the batteries.
- The batteries we supply are only for setting up and testing your TV, please replace them as soon as necessary.
- Always use good quality batteries.

3 Initial Setting

You can automatically set up to 99 TV stations to PR channels PR 1 to PR 99 on this TV.

1 Press the Main power button.

 The Power lamp lights red (power on), then green (TV on).

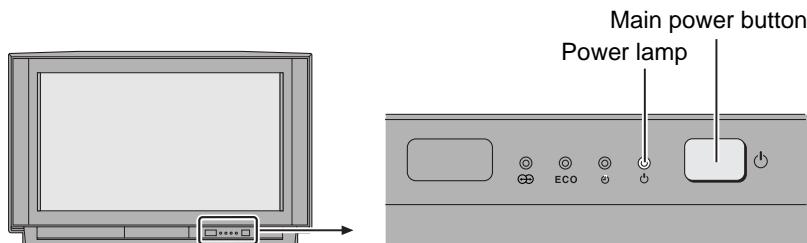

Notes:

- If the power lamp stays red and does not change to green: Your TV is in the standby mode. Press  (Standby) on the remote control to turn your TV on.
- The TV only enters the initial setting mode the first time it is switched on. If you want to change the language and programme settings after this, please refer to page 23.

■ When the TV is first turned on, it enters the initial setting mode, and the JVC logo is displayed.



2 Press .



3 Press to choose ENGLISH.

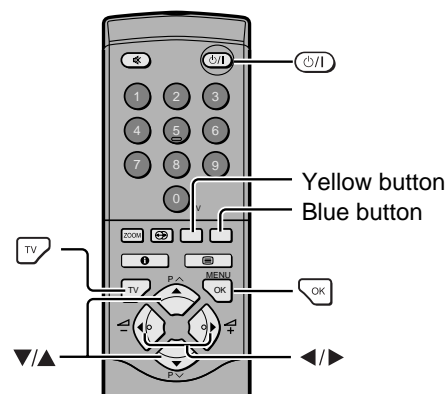
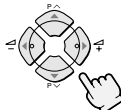

4 Press .



The language is set for the on-screen display description, and the Country menu appears. There are two country menus. Pressing the yellow button changes the country menu as follows:

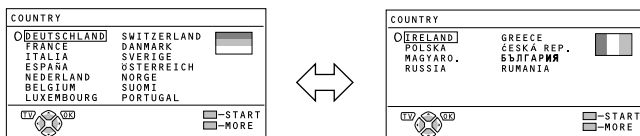

5 Press to choose your country.

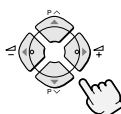

6 Press the blue button.



The Auto Programming starts. The EDIT menu is displayed after the PR channels have been set.

(Continued to the next page)

Preparation

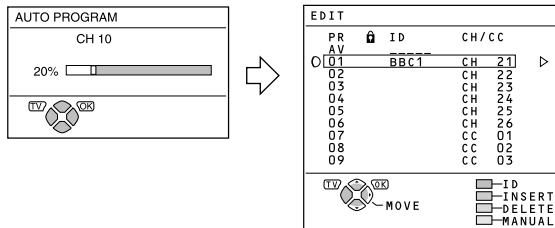

If "ACI START/ACI SKIP" appears in the Auto Program menu:

You can use the ACI (Automatic Channel Installation) function to decode the ACI data and complete the registration of all the TV channels in a short period of time. For details of the ACI function and how to use it, refer to "Using the ACI function" on page 26.

If you don't want to use the ACI function, press **▼/▲** to choose ACI SKIP and then press **OK**.

Notes:

- If this TV identifies a broadcast station name, that station ID is also automatically registered in a PR channel.
- To cancel the Auto programming, press **TV**.
- To edit PR channels or allocate a station to the PR0 (AV) channel, refer to page 24 "Edit/Manual".
- If a station you want to view is not set to a PR channel, manually set it using the Edit menu. (See page 24.)

7 Press **OK** to exit the Edit menu.

The T-V LINK menu is displayed.

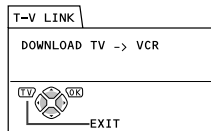

■ When a T-V LINK compatible VCR is connected

8 Turn the VCR on.

9 Press **OK**.

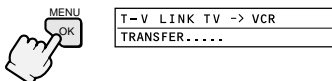

The transmission of PR channel data from the TV to the VCR begins. The display disappears once the data transmission ends.

This completes the Initial Setting procedure.

■ When a T-V LINK compatible VCR is not connected

8 Press **TV**.



The menu disappears. This completes the Initial Settings procedure.

Notes:

- For details about T-V LINK, refer to page 5.
- Depending on the type of VCR, the display may change once data transmission ends. In this case, refer to the VCR's Instruction manual.

T-V LINK Functions

- When a T-V LINK compatible VCR is connected to the EXT-2 Terminal on the TV, the procedures for setting up the VCR and viewing videos are simplified.
- T-V LINK uses the following features:

	Function	Features	Remarks
①	Preset Download	Downloads the PR channel tuning information from the TV to the VCR.	<ul style="list-style-type: none"> • Starts automatically when the initial setting is complete or whenever the Auto Program or Edit/Manual operations from the Install menu are performed. • This function can be operated via VCR operation.
②	DIRECT REC (WYSIWYR)	– What You See Is What You Record – You can record to VCR the images that you are currently viewing on TV by one-touch operation. For details, read the manual for your VCR.	<ul style="list-style-type: none"> • Operate via the VCR. (Operation via the TV is not possible.) “VCR IS RECORDING” is displayed.
③	TV Auto Power On VCR Image View	When the VCR starts playing, the TV automatically turns on and switches to the EXT-2 input mode. When the VCR menu is operated, the TV automatically turns on and switches to EXT-2 input mode.	<ul style="list-style-type: none"> • This function does not operate if your TV’s main power is turned off. Set your TV’s main power to on (standby mode).

- To use T-V LINK:
 - a T-V LINK compatible VCR is necessary.
 - the VCR must be connected to the EXT-2 terminal on the TV by a fully wired SCART cable.

■ T-V LINK compatible VCRs:

In addition to all JVC VCRs that have the T-V LINK logo, any VCR that has one of the following logos are available for use:

- “Q-LINK” (a trademark of Panasonic Corporation)
- “Data Logic” (a trademark of Metz Corporation)
- “Easy Link” (a trademark of Phillips Corporation)
- “Megalogic” (a trademark of Grundig Corporation)
- “SMARTLINK” (a trademark of Sony Corporation)

- These VCRs may support some or all of the features described above. For details, refer to the VCR Instruction Manual.

■ When “FEATURE NOT AVAILABLE” is displayed:

If “FEATURE NOT AVAILABLE” is displayed after download execution, the download was not performed correctly. Confirm the following before re-executing download:

- that the VCR power is turned on.
- that the VCR is T-V LINK compatible.
- that the VCR is connected to the EXT-2 terminal.
- that the SCART cable is fully wired.

■ Operating Precautions for DIRECT REC:

- Generally, the VCR cannot record a channel that cannot be received properly by the VCR’s tuner even though that channel could be viewed on the TV.
- In the following conditions, the VCR will stop recording if the TV is turned off, if the TV channel or input is switched, or if the menu is displayed on the TV:
 - When recording images from an external device connected to the EXT-1, EXT-3 or EXT-4 terminal.
 - When recording a channel after it has been unscrambled on a decoder.
 - When recording a channel by using the TV’s output because that channel cannot be properly received on the VCR’s tuner.

Note:

- Not all VCRs support this type of data communication. Some may support certain features and not support others. For complete details, refer to the VCR Instruction Manual.

Note:

- Some VCRs can record a channel by using the TV’s output if that channel can be viewed on the TV, even though the channel cannot be received properly by the VCR’s tuner. For details, refer to the VCR Instruction Manual.

Basic Operation

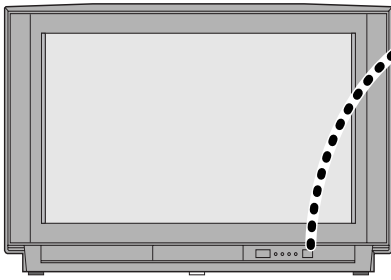

Turn the Main power on.



The Power lamp lights red and your TV is in the standby mode.

- If the Power lamp lights green, the TV is already on.

- To turn the Main power off:



The Power lamp goes off.

- To save energy, turn the main power off if not using the TV for a long period of time.

Operating with the Remote Control

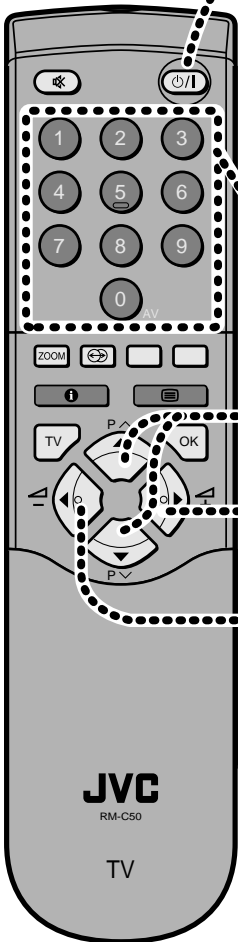

1

Turn the TV on from standby mode.



or



or



or



The Power lamp lights red to green.

- To turn the TV off:



The Power lamp changes from green to red.
The TV enters standby mode.

2

Choose a TV channel.



or



Example

- PR12 → press 1 and 2.
- PR6 → press 6.

Use the PR List:

1 Display the PR List.



PR LIST		
PR	Lock	ID
AV		
01	Ⓛ	BBC1
02		
03		
04		
05		
06		
07		
08		
09		
-10 TV +10		

2 Choose a TV channel.

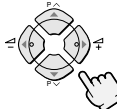

3 Press OK.



3

Adjust the volume.



The Volume indicator appears and the volume changes as -/+ are pressed.

Notes:

- For channels with Child Lock set, a Ⓛ (Locked) mark is displayed next to the channel number.
- Using the PR List, the EXT terminal can also be chosen. Each EXT terminal is after the PR 99 channel.
- If you don't have a clear picture or no colour appears, change the colour system manually. See "Colour System" on page 17.
- If the picture is tilted, correct the picture. See "Picture Tilt" on page 17.

Watch images from external devices.

Choosing an EXT terminal or PR 0 (AV) channel.

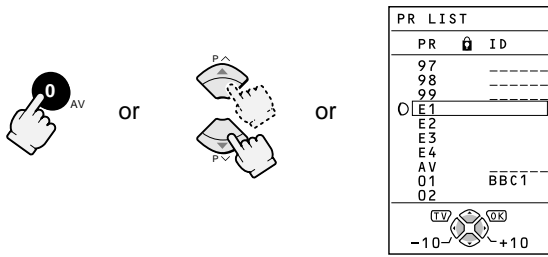

- The EXT terminals are registered after the PR 99 channel.
- Pressing **0** AV button changes the choice as follows:

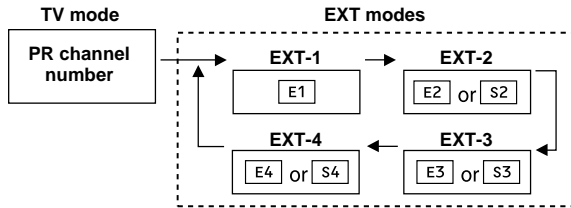

- To return to a TV channel:

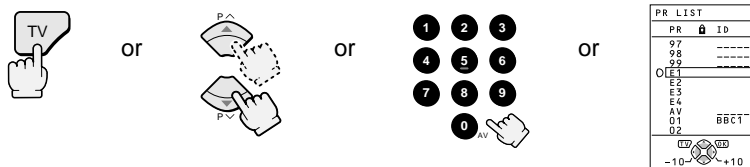

- When the TV and VCR are connected only by the RF cable, the VCR RF channel* must be preset to the PR 0 (AV) channel to view VCR video. Choosing the PR 0 (AV) channel allows you to view images from VCR video. Pressing **0** AV button changes the choice as follows:

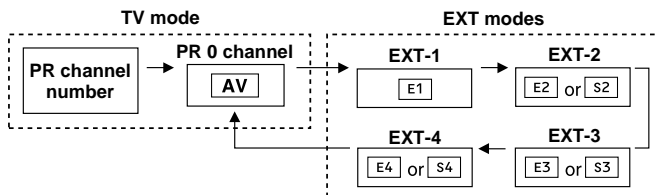

Notes:

- To use S-Video mode to view input from an S-VHS VCR, see "To choose S-VIDEO input" on page 20. When choosing EXT-2, EXT-3 or EXT-4 input terminals as S-VIDEO input, E2, E3 or E4 changes to S2, S3 or S4 in the display.
- If you don't have a clear picture or no colour appears, change the colour system manually. (See "Colour System" on page 17.)
- When choosing an EXT terminal with no input signal, the EXT number and ID become fixed on screen.

Note:

- The VCR RF channel is the channel that is sent as the RF signal from the VCR. To set the VCR RF channel to the PR 0 (AV) channel, refer to "Edit/Manual" on page 24. Also refer to the manual provided with the VCR.

Operating with the Buttons on the TV

(Behind the front cover)

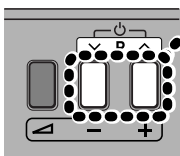

1 Turn the TV on from standby mode.

2 Choose a channel or an EXT terminal.

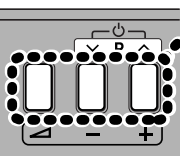

3 Adjust the volume.

1 Press **▲**.
The volume level indicator appears.

2 Press **-/+** while the volume level indicator is displayed.
Indicator is displayed.

Remote Control Buttons and Functions

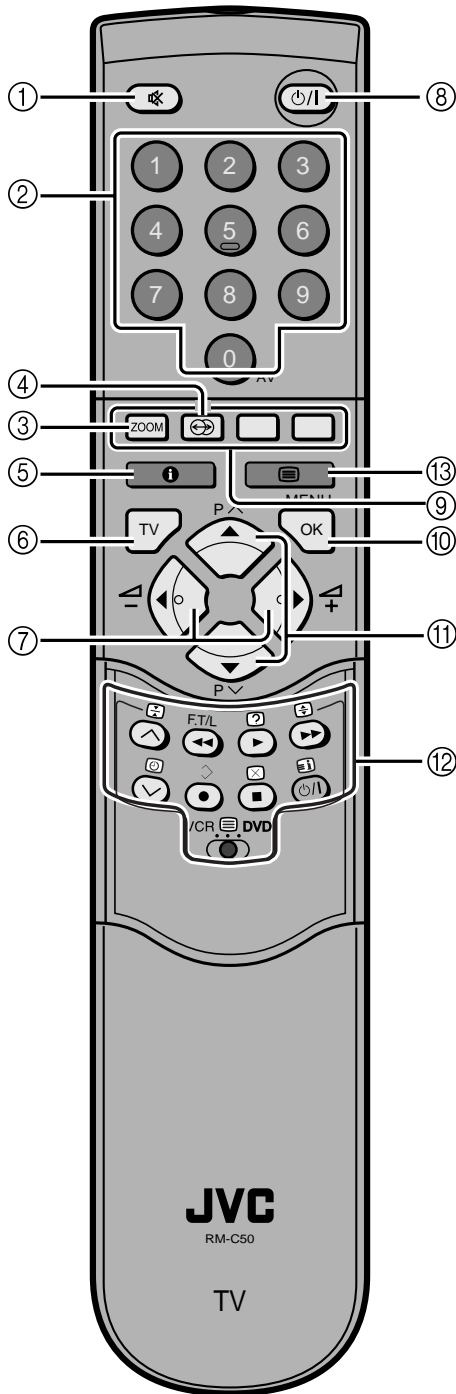

① Muting Button

You can turn the volume off instantly.

Pressing  (Muting) changes the current volume to "0".

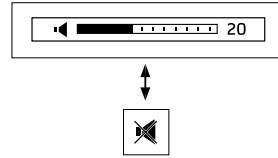

② Number Buttons

You can choose a channel by entering the channel number.

Example:

- PR 12 → press **1** and **2**.
- PR 6 → press **6**.

■ You can choose an EXT terminal or PR 0 (AV) channel by pressing **0_{AV}** button repeatedly.

③ ZOOM Button

You can change the screen size. (See page 9.)

- 1 Press  and press **▼/▲** to choose ZOOM mode.

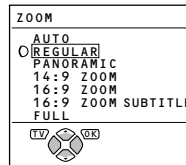

- 2 Press .

The picture expands and the chosen ZOOM mode is displayed in about 5 seconds.

Notes:

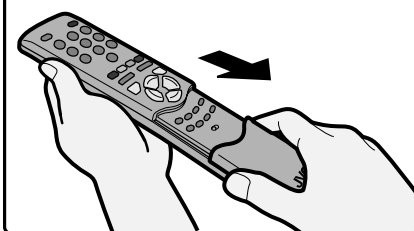

- For details, see next page.
- You can preset a ZOOM mode for the normal picture. See "4:3 Auto Aspect" on page 17.

How to open the cover

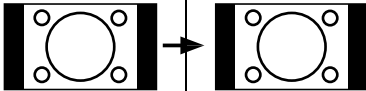
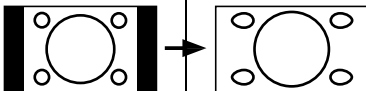

Remote Control Buttons and Functions

ZOOM Button (continued)

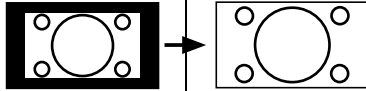
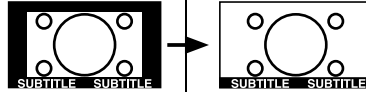
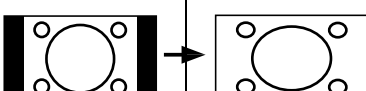
Mode	Recommended Picture (Aspect)	Display	Remarks
AUTO	Any picture format except Normal Picture (4:3 Aspect Ratio)	The picture will be automatically displayed in the optimum screen size.	<ul style="list-style-type: none"> AUTO may not function properly with poor signal quality. In this case, choose an optimum ZOOM mode manually.
	Normal Picture (4:3 Aspect Ratio)	Displayed in accordance with the zoom mode set on the 4:3 Auto Aspect menu. (See page 17 for further details.)	
REGULAR	Normal Picture (4:3 Aspect Ratio)		<ul style="list-style-type: none"> Use to view a normal picture (4:3 aspect ratio) unchanged.
PANORAMIC	Normal Picture (4:3 Aspect Ratio)		<ul style="list-style-type: none"> This mode stretches the left and right sides of a normal picture to fill the screen, in a way that does not appear unnatural. The top and bottom of the picture are slightly cut off.
14:9 ZOOM	Wide Picture (14:9 Aspect Ratio)		
16:9 ZOOM	Wide Picture (16:9 Aspect Ratio)		
16:9 ZOOM SUBTITLE	Wide Picture (16:9 Aspect Ratio) with Subtitles		
FULL	Normal Picture (4:3 Aspect Ratio)		<ul style="list-style-type: none"> This mode uniformly stretches the left and right sides of a normal picture (4:3 aspect ratio) to fill the wide TV screen. Use for pictures with a 16:9 aspect ratio that have been squeezed into a normal picture (4:3 aspect ratio), you can restore their original dimensions.

Note:

- This television supports WSS (wide-screen signals). When broadcasts with WSS are received with the ZOOM mode set at AUTO, the most suitable ZOOM mode is automatically selected in accordance with the WSS.

Adjusting the visible area of the picture.

If subtitles or the top (or bottom) of the picture are cut off, adjust the visible area of the picture manually.



1 Press .

The ZOOM menu appears.

2 Press  to display the ZOOM mode indication.

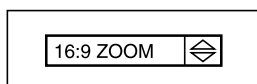
Indicator is displayed.



3 Before it disappears, press / to adjust the visible area vertically.

Note:

- You cannot adjust the visible area in REGULAR and FULL mode.

Remote Control Buttons and Functions

④ Hyper Sound Button

You can enjoy sounds with a wider ambience.

Pressing  (Hyper Sound) turns the Hyper Sound on or off.

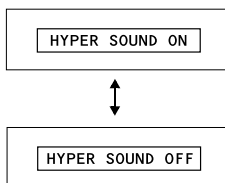

Notes:

- The Hyper Sound function does not work properly with mono sound.
- The Hyper Sound lamp lights while the Hyper sound function is in use.
- The Hyper Sound function can be also turned on or off by using the Sound Setting menu. For details, see “Hyper Sound” on page 18.

⑤ Information Button

Pressing  (Information) changes the display as follows.

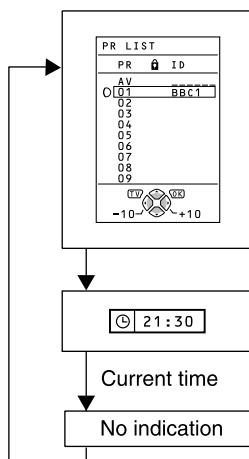

About the PR List:

You can choose TV channels and EXT terminals operating the PR List. For details, see “Use the PR List” on page 6.

About the current time display:

This TV uses teletext data to set the current time.

- If the TV has not received a station that has teletext data since it was turned on, the time display is blank. To see the current time, choose a station that is broadcasting teletext data. As long as you do not turn off the TV, then even if you choose other stations, the time will still be displayed.
- When watching videos, the wrong current time is sometimes displayed.

Note:

- When an EXT terminal with no input signal is chosen, the EXT number and ID become fixed on the screen.

- The  (Information) button is also used for the menu operation. Please refer to “Menu Operation” on page 14 for more information.

⑥ TV Button

You can return to the TV mode instantly by pressing .

- The  button is also used for the menu operation. Please refer to “Menu Operation” on page 14 for more information.

⑦ ◀/▶ Buttons

You can adjust the volume.

- The  buttons are also used for the menu operation. Please refer to “Menu Operation” on page 14 for more information.

⑧ Standby Button

Pressing  (Standby) button turns the TV on or off.

- When the TV is turned on, the power lamp changes from red to green.

⑨ Colour Buttons

The colour buttons are used for the teletext operations or the menu operations. Please refer to “Teletext Control Buttons and VCR/  /DVD Switch” on page 12 or “Menu operation” on page 14 for more information.

⑩ OK Button

The  button is used for menu operation. Please refer to “Menu Operation” on page 14 for more information.

⑪ ▼/▲ Buttons

You can choose a channel by pressing the  buttons.

- The  buttons are also used for the menu operation. Please refer to “Menu Operation” on page 14 for more information.

12 VCR/DVD Control Buttons and VCR/☰/DVD Switch

These buttons can be used to operate a JVC brand VCR or DVD player. Pressing the button having the same appearance as the original remote control button of a device makes the function work in the same way as the original remote control.

1 Set the VCR/☰/DVD Switch to the VCR or DVD position.

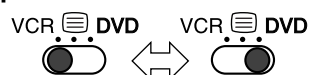

VCR:

When you are operating the VCR, set the switch to the VCR position.

DVD:

When you are operating the DVD player, set the switch to the DVD position.

☰ (Text):

When you are viewing Teletext programmes, set the switch to the ☰ (Text) position.

2 Press the VCR/DVD Control Button to control your VCR or DVD player.



Notes:

- If your device is not made by JVC, these buttons cannot be used.
- Even if your device is made by JVC, some of these buttons or any one of the buttons may not work, depending on the device.
- You can use the ∇/∧ buttons to choose a TV channel. The VCR will receive or choose the chapter the DVD player plays back.
- Some DVD player models use the ∇/∧ buttons for both operating of Fast forward/backward functions and choosing the chapter. In this case, the ◀◀/▶▶ the buttons do not work.

Remote Control Buttons and Functions

9 12 13 Teletext Control Buttons and VCR/☰/DVD Switch

Basic operation

You can view three types of teletext broadcasts on the TV; FLOF (Fastext), TOP and WST.

- 1 Choose a channel with a teletext broadcast.
- 2 Set the VCR/☰/DVD switch to the ☰ (Text) position.



- 3 Display the teletext.



Pressing ☰ (Text) change the mode as follows:

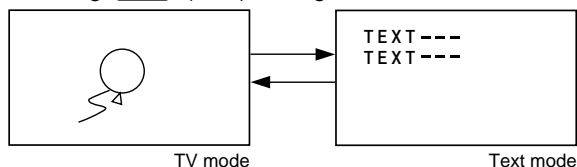

- 4 Choose a teletext page.

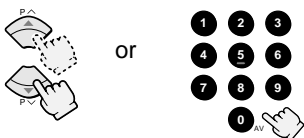

- To return to the TV mode:

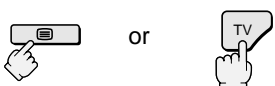

Notes:

- If you have trouble receiving teletext broadcasts, consult your local dealer or the teletext station.
- Category names of teletext pages may appear instead of page numbers.
- In Text mode, ZOOM mode is fixed to FULL mode.
- None of the Menu operations are possible when viewing a teletext programme.
- Language display depends on the country which was set on the Country menu. If characters on a Teletext programme do not appear properly, change the Country Setting to other country's. For detail, see "Changing the Country Setting" on page 26.

Using the List Mode

You can store the numbers of your favourite teletext pages and call them up quickly using the colour buttons.

To store the page numbers

- 1 Engage the List mode.

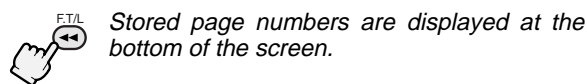

- 2 Choose the position, then enter the page number.

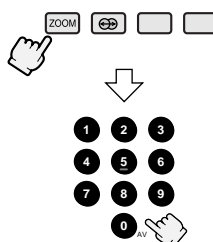

- 3 Press ☰ (Store) and hold on.

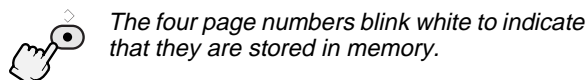

To call up a stored page

- 1 Engage the List mode.



To cancel the List mode:



- 2 Press a colour button to which a page has been assigned.



■ Hold

You can hold a teletext page on the screen for as long as you want, even while several other teletext pages are being received.

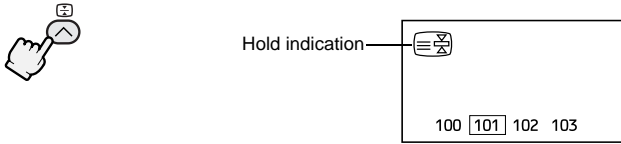

To cancel the hold:



■ Sub Page

Some teletext pages include sub-pages that are automatically displayed. You can hold any sub-page, or view it at any time.

1 Display the sub-page list.

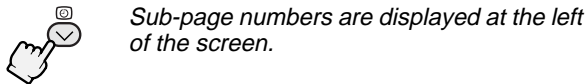

Colour*	Meaning of sub-page number
Yellow	Currently being displayed.
White	Can be displayed.
Blue or Red	Cannot be displayed and it is not sent.

*: Background colour of the sub-page number.

2 Choose a sub-page.



● To cancel sub-page:



■ Reveal

Some teletext pages include hidden text (such as answers to a quiz).

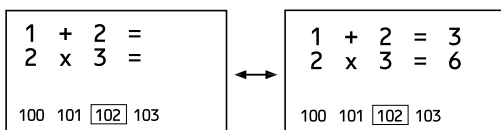

■ Size

You can double the height of the teletext display.

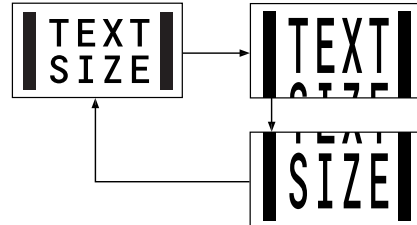

■ Index

You can return to the index page instantly.



FLOF (Fastext)/TOP/WST:

Returns to page 100 or a previously specified page.

List mode:

Returns to the page number displayed in the lower left area of the screen.

■ Cancel

You can search for a teletext page while watching TV.

1 Choose a teletext page.

The TV searches for a teletext page.

2 Cancel teletext mode temporarily.



The TV programme appears.

When the TV finds the teletext page, its page number appears in the upper left of the screen.

3 Return to a teletext page when the page number is on the screen.



Menu Operation

1 Display MENU.

 The MENU (main menu) appears.

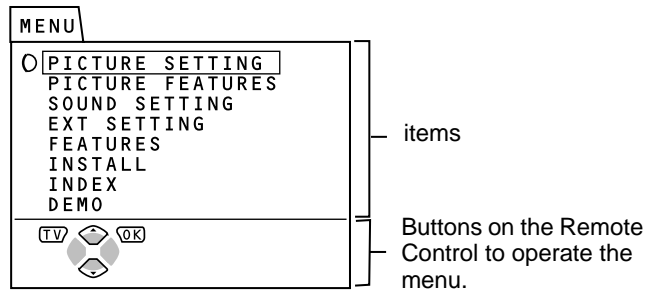

2 Choose an item.



3 Display the sub-menu.

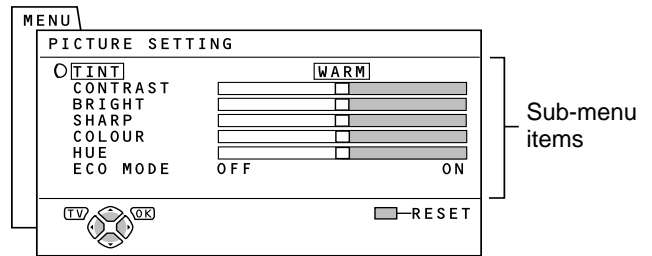

4 Choose a Sub-menu item.



5 Change the setting.



- Depending on the Sub-menu display, the following buttons can be used.

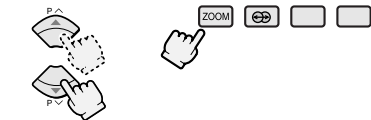

6 Complete the setting.

 The menu disappears.

To return to the previous menu or exit the MENU.



To exit the MENU instantly.



Picture Setting

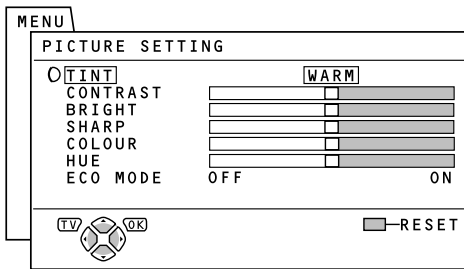

1 Display MENU.



2 Choose PICTURE SETTING.



3 Display the Picture Setting menu.



Tint

You can choose one of three Tint modes to adjust the picture settings automatically.

1 Press ▼/▲ to choose TINT.

2 Press ◀/▶ to choose a mode.

COOL:

A cool white colour base with a boost in the colour and contrast levels that creates a more vivid picture.

WARM:

A warm orange/red colour base that creates the appropriate colour and contrast levels for watching films.

NORMAL:

A normal white colour base with normal colour and contrast levels.

3 Press .

This completes the setting.

Picture Adjustment

You can adjust the picture to your liking.

1 Press ▼/▲ to choose an item.

2 Press ◀/▶ to adjust the setting.

◀	Item	▶
Lower	CONTRAST (picture contrast)	Higher
Darker	BRIGHT (picture brightness)	Brighter
Softer	SHARP (picture sharpness)	Sharper
Lighter	COLOUR (picture colour)	Deeper
Reddish	HUE (picture hue)	Greenish

Note:

- You can adjust the HUE (picture hue) only when the colour system is NTSC 3.58 or NTSC 4.43.

- To return to the default settings, press the blue button.

3 Press .

This completes the setting.

Eco Mode

When you set the Eco Mode to ON, the screen contrast is automatically adjusted to a setting suitable for the brightness of your room.

This reduces eye strain and the power consumption of the TV.

1 Press ▼/▲ to choose ECO MODE.

2 Press ◀/▶ to choose ON.

- To cancel the Eco Mode, choose OFF.

3 Press .

This completes the setting.

- If you set the Eco Mode to ON, the Eco lamp lights.

Picture Features

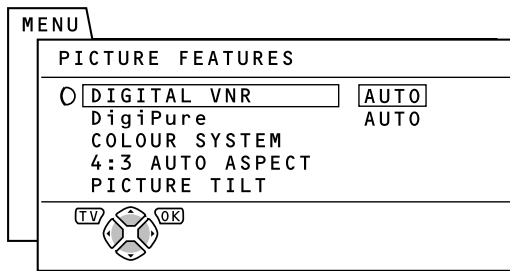

1 Display MENU.



2 Choose PICTURE FEATURES.



3 Display the Picture Features menu.



Digital VNR

The Digital VNR function is a function to reduce the noise which is currently included in the picture. However, if the Digital VNR effect is increased more than necessary, it has a detrimental effect of reducing the sharpness of the picture. By setting the Digital VNR function to AUTO, the TV will automatically adjust the effect level of the Digital VNR function to match the amount of noise in the picture and give the optimum noise reduction effect for the picture.

1 Press ▼/▲ to choose DIGITAL VNR.

2 Press ◀/▶ to choose AUTO.

MIN:

The effect of the Digital VNR function is kept at the minimum irrespective of the amount of noise in the picture. When viewing an excellent quality picture which contains almost no noise, the picture sharpness may be improved by changing the Digital VNR setting from AUTO to MIN. However, since the noise reduction effect becomes very low, this is not suitable for a picture which contains a lot of noise.

MAX:

The effect of the Digital VNR function is kept at the maximum irrespective of the amount of noise in the picture. When viewing a picture which contains a lot of noise, the picture noise may be further reduced by changing the Digital VNR setting from AUTO to MAX. However, since using the noise reduction at maximum may have the reverse effect of reducing the sharpness of the picture, MAX is not suitable for an excellent quality picture which contains almost no noise.

3 Press .

This completes the setting.

DigiPure

The DigiPure function is a function which uses digital edge compensation to ensure that every part of the picture has the optimum edge compensation. This edge compensation means that you are able to enjoy a clear, natural looking picture. However, using the DigiPure function to a large extent on a picture which contains a lot of noise may have the reverse effect of amplifying the noise.

By setting the DigiPure function to AUTO, the TV will automatically adjust the effect level of the DigiPure function to match the amount of noise in the picture and give the optimum edge compensation effect for the picture.

1 Press ▼/▲ to choose DigiPure.

2 Press ◀/▶ to choose AUTO.

MIN:

The effect of the DigiPure function is kept at the minimum irrespective of the amount of noise in the picture. When viewing a picture which contains a lot of noise, the picture noise may become less noticeable by changing the DigiPure setting from AUTO to MIN. However, since the edge compensation effect becomes very low, this is not suitable for an excellent quality picture which contains almost no noise.

MAX:

The effect of the DigiPure function is kept at the maximum irrespective of the amount of noise in the picture. When viewing an excellent quality picture which contains almost no noise, the picture may be further improved to a clear, natural looking picture by changing the DigiPure setting from AUTO to MAX. However, since using the edge compensation at maximum may have the reverse effect of amplifying the noise, MAX is not suitable for a picture which contains a lot of noise.

3 Press .

This completes the setting.

Note:

- The DigiPure setting can be changed using the buttons on the TV's front panel. Pressing the  button for 5 seconds or longer causes the current DigiPure setting to be displayed. Change the DigiPure setting while it is being displayed using the - / + buttons.

Colour System

The colour system is automatically chosen, but if the picture is not clear or no colour appears, choose the colour system manually.

- 1 Press **▼/▲** to choose **COLOUR SYSTEM**. Then Press **OK**.

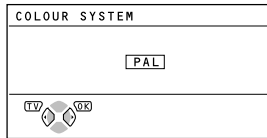

- 2 Press **◀/▶** to choose the appropriate colour system.

PAL:

PAL system.

SECAM:

SECAM system.

NTSC3.58:

NTSC 3.58 MHz system.

NTSC4.43:

NTSC 4.43 MHz system.

AUTO:

Automatic colour system selection.

Notes:

- The **AUTO** may not function properly with poor signal quality. If the picture is abnormal in **AUTO** mode, choose another colour system manually.
- When in the **TV** mode (PR 1 to PR 99), you cannot choose **AUTO**, **NTSC 3.58** or **NTSC 4.43**.
- When in the **TV** mode (PR 0), you cannot choose **NTSC 3.58** or **NTSC 4.43**.

- 3 Press **OK**.

This completes the setting.

4:3 Auto Aspect

You can preset one of three **ZOOM** modes, **REGULAR**, **PANORAMIC** or **14:9 ZOOM**, as the **ZOOM** mode for the normal picture (4:3 aspect ratio).

- 1 Press **▼/▲** to choose **4:3 AUTO ASPECT**. Then press **OK**.

The **4:3 AUTO ASPECT** menu appears.

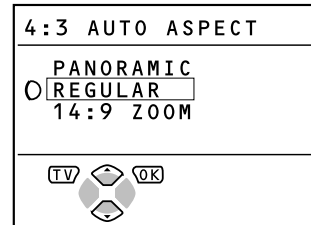

- 2 Press **▼/▲** to choose a **ZOOM** mode.

- 3 Press **OK**.

This completes the setting.

Picture Tilt

There are cases where the effects of the magnetic pull from the earth may make the picture tilt. If this happens, correct the picture as follows.

- 1 Press **▼/▲** to choose **PICTURE TILT**. Then press **OK**.

The **PICTURE TILT** menu appears.

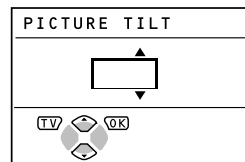

- 2 Press **▼/▲** until the picture becomes horizontal.

- 3 Press **OK**.

The correction is complete.

Sound Setting

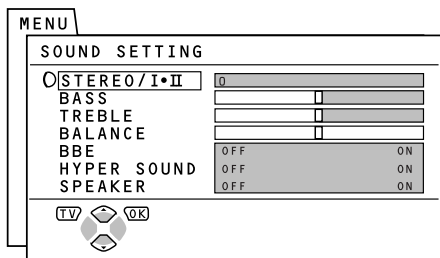

1 Display MENU.



2 Choose SOUND SETTING.



3 Display the Sound Setting menu.



Stereo / I • II

You can choose Multi Sound mode for stereo broadcast programmes and bilingual programmes.

Note:

- Multi Sound has no effect on programmes other than A2 (B/G, D/K) or NICAM (B/G, D/K, L, I) broadcast programmes.

1 Press ▼/▲ to choose STEREO / I • II.

Notes:

- The Multi Sound mode display is different from the broadcast programme.
- The Multi Sound function does not work in the EXT modes. And the STEREO / I•II does not appear in SOUND SETTING menu.

2 Press ◀/▶ to choose a Multi Sound mode.

- ⊕ : Stereo sound
- I : Bilingual I (Sub I)
- II : Bilingual II (Sub II)
- : Normal sound

3 Press .

This completes the setting.

Note:

- When you display the current PR channel number, the current Multi Sound mode appears for approximately 3 seconds.

Sound Adjustment

You can adjust the sound to your liking.

1 Press ▼/▲ to choose an item.

2 Press ◀/▶ to adjust it.

◀	Item	▶
Weaker	BASS	Stronger
Weaker	TREBLE	Stronger
Left	BALANCE	Right

3 Press .

This completes the settings.

BBE

You can use the BBE function to enjoy easy-to-listen sound that is faithful to the original sound recorded.

1 Press ▼/▲ to choose BBE.

2 Press ◀/▶ to choose ON.

To cancel the BBE function :
Press ◀/▶ to choose OFF.

3 Press .

This completes the setting.

- Licensed by BBE Sound, Inc. BBE is a registered trademark of BBE Sound, Inc.

Hyper Sound

You can enjoy sounds with a wider ambience.

1 Press ▼/▲ to choose HYPER SOUND.

2 Press ◀/▶ to choose ON.

- To cancel the Hyper Sound, choose OFF

3 Press .

This completes the setting.

Using the (Hyper Sound) button.

You can turn on the Hyper Sound with one touch. For details, refer to "Hyper Sound Button" on page 10.

Notes:

- The Hyper Sound function does not work properly with mono sound.
- The Hyper Sound lamp lights while the Hyper sound function is in use.

Speaker

It is possible to prevent the sound from being emitted from the TV speakers. This function should only be used to emit the sound from an audio system connected to the television as a substitute for the TV speakers.

When you use your audio system instead of the TV speakers:

Please refer to "Connecting an Audio System" on page 29.

To output the sound from TV speakers:

1 Press ▼/▲ to choose SPEAKER.

2 Press ◀/▶ to choose ON.

3 Press .

This completes the setting.

EXT Setting

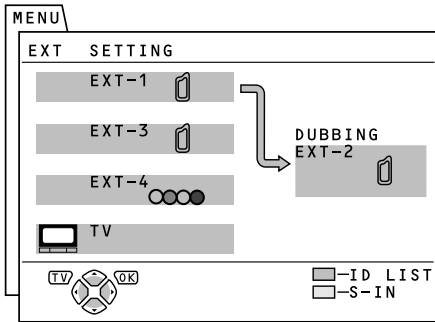

1 Display MENU.



2 Choose EXT SETTING.



3 Display the EXT Setting menu.



EXT Setting

You can choose S-VIDEO or normal input for EXT-2, EXT-3 and EXT-4 terminals, and you can give an EXT ID to each EXT input terminal.

To choose S-VIDEO input

1 Press ◀/▶/▼/▲ to choose an EXT terminal.

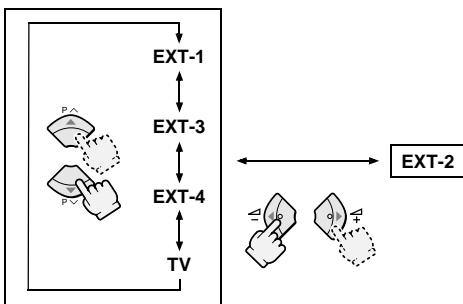

2 Press the yellow button.

The S-VIDEO input indication appears.

- To choose normal input, press the yellow button again.

3 Press .

This completes the setting.

To give an EXT ID

1 Press ◀/▶/▼/▲ to choose an EXT terminal.

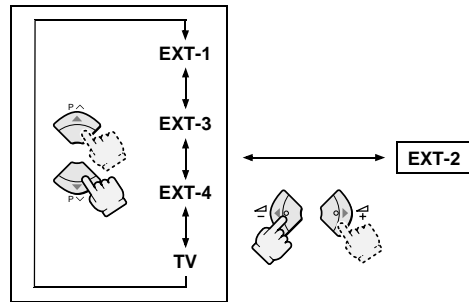

2 Press the blue button.

The ID LIST appears.

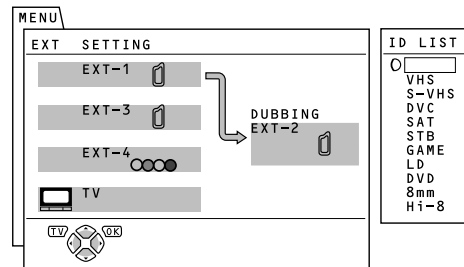

3 Press ▼/▲ to choose an EXT ID.

Note:

- To erase the EXT ID, choose a blank space.

4 Press .

The EXT ID is set to the EXT terminal.

5 Press .

This completes the setting.

Dubbing

You can choose output to a VCR or other device connected to the EXT-2 terminal. Note that you cannot output from the EXT-2 terminal when the TV is turned off.

Note:

- RGB signals from TV games and Teletext screens cannot be output from EXT-2 terminal.

1 Press ◀/▶ to choose EXT-2.

2 Press ▼/▲ to choose the output.

If you choose TV:

The sound and picture of the currently chosen channel is output to EXT-2 and this output can be recorded on a VCR connected to the EXT-2 terminal while watching a video input from other terminals.

3 Press .

This completes the setting.

Features

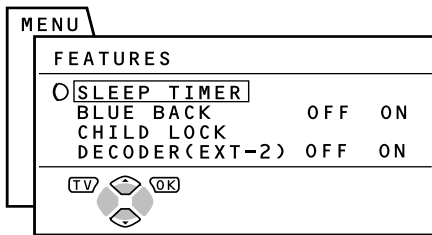

1 Display MENU.



2 Choose FEATURES.



3 Display the Features menu.



Sleep Timer

You can set the TV to automatically turn off after a specified period of time.

Note:

- The Sleep Timer does not turn off the Main power.

1 Press ▼/▲ to choose SLEEP TIMER. Then press .

The Sleep Timer menu appears.

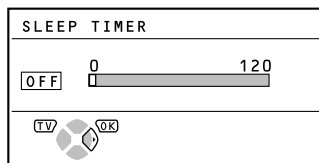

2 Press ◀/▶ to choose a period of time.

You can set the period of time a maximum of 120 minutes in 10 minute increments.

3 Press .

The Sleep Timer lamp lights if you set the Sleep Timer.

To display the remaining time:

Do step 1 to display the Sleep Timer menu, and press  after checking the remaining time.

To cancel the Sleep Timer:

Do step 1 to display the Sleep Timer menu. Press ◀ to choose "OFF", and then press .

- The Sleep Timer lamp goes out.

Note:

- One minute before the Sleep Timer turns off the TV, "GOOD NIGHT!" appears.

Blue Back

You can set the TV to automatically change to a blue screen and mute the sound when a weak signal or no signal is received or when there is no input from an external device.

1 Press ▼/▲ to choose BLUE BACK.

2 Press ◀/▶ to choose ON.

- To cancel the Blue Back, choose OFF.

3 Press .

This completes the setting.

Child Lock

You can lock some channels to prevent your children from watching them.

■ To set the CHILD LOCK

1 Press ▼/▲ to choose CHILD LOCK. Then press (number 0).

The Set ID No. menu appears.

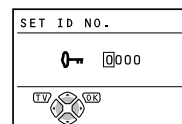

2 Enter the ID number.

- Press ▼/▲ to choose a number.
- Press ◀/▶ to move the cursor.

3 Press .

The Child Lock menu appears.

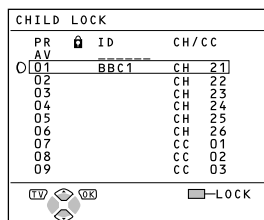

Features

4 Press ▼/▲ to choose a channel, then press the blue button.

The  (locked) mark appears, and the chosen channel is locked.

- To cancel the Child Lock, press the blue button again.
- Repeat step 4 to lock all channels which you want to lock.

5 Press .

This completes the setting.

Notes:

- You cannot choose a locked channel using the ▼/▲ buttons on the remote control nor the P ▼/▲ buttons on the TV.
- Even if a locked channel is displayed, the programme cannot be watched.

■ To watch a locked channel

1 Press the number buttons to choose a locked channel.

The  (locked) mark appears.

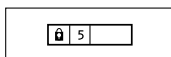

2 Press (Information).

The ID No. input menu appears.

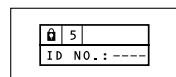

3 Press the number buttons to enter the ID number.

The locked channel can now be watched.

If you forget the ID number:

Do steps 1 of "To set the Child Lock". After confirming the ID number, press  to exit the menu.

Decoder (EXT-2)

When you connect a Decoder to a T-V LINK compatible VCR, you have to set the Decoder (EXT-2) to ON for watching scrambled channels.

1 Choose a scrambled channel.

The scrambled picture appears.

- If the picture is unscrambled you don't need to change the Decoder (EXT-2) setting.

2 Press to display MENU. Then Press ▼/▲ to choose FEATURES.

3 Press to display the Features menu.

4 Press ▼/▲ to choose DECODER (EXT-2).

5 Press ◀/▶ to choose ON.

6 Press .

The T-V LINK menu appears.

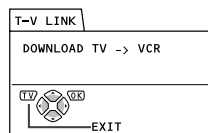

7 Press .

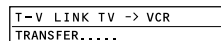

The translation of channel data from the TV to the VCR begins. The display disappears once the data transmission ends.

- Repeat steps 1 to 7 watch a different channel using the decoder.

Note:

- Depending on the type of VCR, the display may change once data transmission ends. In this case, refer to the VCR's manual.

Install

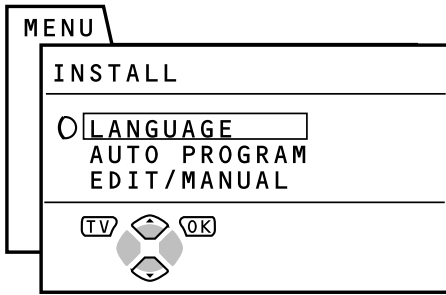

1 Display MENU.



2 Choose INSTALL.



3 Display the Install menu.



Language

You can choose one of 15 languages for the on-screen display.

1 Press ▼/▲ to choose LANGUAGE, then press OK.

The Language menu appears.



2 Press ◀/▶/▼/▲ to choose a language.

3 Press OK.

This completes the setting.

Auto Program

You can automatically allocate up to 99 stations to the PR channels (PR 1 to PR 99) on this TV.

1 Press ▼/▲ to choose AUTO PROGRAM, then press OK.

The Country menu appears.

There are two country menus. Pressing the yellow button changes the country menu as follows:

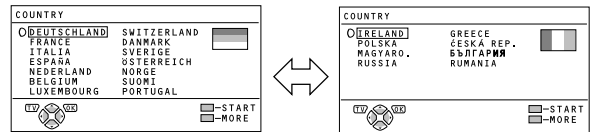

2 Press ◀/▶/▼/▲ to choose your country.

3 Press the blue button.

The Auto Programming starts. The Edit menu appears after the PR channels have been set.

If "ACI START/ACI SKIP" appears in the Auto Program menu:

You can use the ACI (Automatic Channel Installation) function to decode the ACI data and complete the registration of all the TV channels in a short period of time. For details of the ACI function and how to use it, refer to "Using the ACI function" on page 26. If you don't want to use the ACI function, press ▼/▲ to choose ACI SKIP and then press OK.

Notes:

- If this TV identifies a broadcast station name, that station ID is also automatically registered in a PR channel.
- To cancel the Auto programming, press TV.
- If a station you want to view is not set to a PR channel, manually set it using the Edit menu. (See page 24.)
- To edit PR channels or set a station to PR 0 (AV) channel, refer to page 24 "Edit/Manual".

4 Press OK.

This completes the procedure and the T-V LINK menu appears.

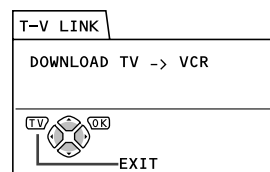

When a T-V LINK compatible VCR is connected:

You can transmit the latest PR channel data from the TV to the VCR. Carry out the procedure described in "Downloading the PR channel data to the VCR" on page 26.

When a T-V LINK compatible VCR is not connected:

You cannot transmit the latest PR channel data from the TV to the VCR.

Press TV to exit the T-V LINK menu.

Edit/Manual

You can change PR channel settings.

- You can delete an unwanted station from a PR channel,
- You can change the PR channel number of a station,
- You can add station IDs to PR channels,
- You can insert a new station to a PR channel, or
- You can manually set the desired station to a PR channel.

- 1 Press **▼/▲** to choose EDIT/MANUAL, then press **OK**.

The Edit menu appears.

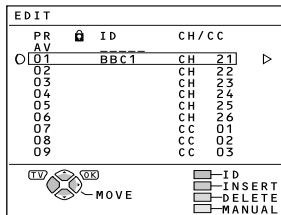

- 2 Use any of the following procedures to edit the PR channel setting.

- 3 Press **OK**.

This completes the procedure and the T-V LINK menu appears.

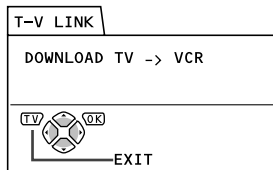

When a T-V LINK compatible VCR is connected:

You can transmit the latest PR channel data from the TV to the VCR. Carry out the procedure described in "Downloading the PR channel data to the VCR" on page 26.

When a T-V LINK compatible VCR is not connected:

You cannot transmit the latest PR channel data from the TV to the VCR. Press **TV** to exit the T-V LINK menu.

Deleting a station

- 1 Press **▼/▲** to choose the station you want to delete then press the yellow button.

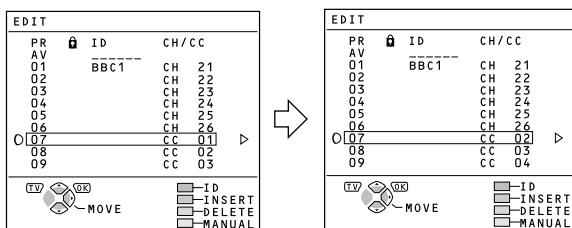

Note:

- If you delete a station from a PR channel, the following stations' PR channel numbers move back by one.

Changing the PR channel number

- 1 Press **▼/▲** to choose the station, then press **▶**.

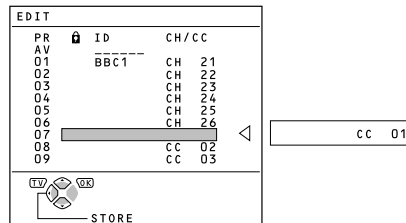

- 2 Press **▼/▲** to move the station to the desired PR channel number.

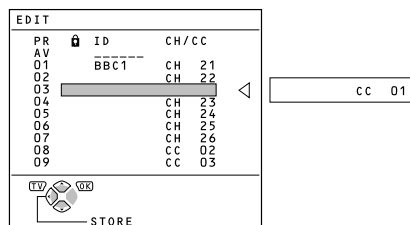

- To cancel the operation, press **Info** (Information).

- 3 Press **◀**.

Adding a Station ID

- 1 Press **▼/▲** to choose the station, then press the red button.

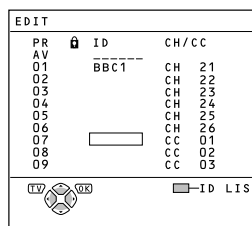

- 2 Press **▼/▲** to choose the first character of the desired Station ID.

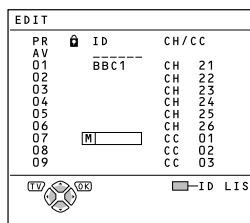

- Press the blue button.
The ID List menu appears.

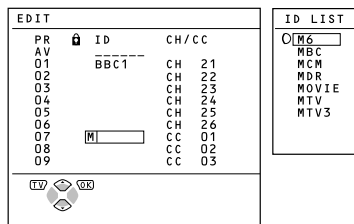

- Press ∇/\blacktriangle to choose the station ID.
 - To cancel the operation, press (Information).
- Press .

Adding a Station ID name of your own:
Do the following procedure in place of "Adding a Station ID".

- Press ∇/\blacktriangle to choose the station, then press the red button.
- Press ∇/\blacktriangle to choose a character, then press $\blacktriangle/\blacktriangleleft$ to move the cursor.
- Repeat step 2 to complete the Station ID, then press .

■ Inserting a new station

If you want to insert French stations to the PR channels:
You have to set the Country setting to FRANCE before inserting French stations to the PR channels.
If your Country setting is not FRANCE, change the Country setting to FRANCE. To change the Country Setting, refer to "Changing the Country Setting" on page 26.

- Press ∇/\blacktriangle to choose the PR channel, then press the green button.

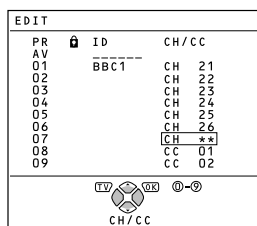

- Press ∇/\blacktriangle to choose CC or CH

To set a French station:
Choose CH1, CH2, CC1 or CC2.

- To cancel the operation, press (Information).

Note:

- For details on the relationship between the displayed CH/CC number and the actual channel number, see the Channel Table on page 30.

- Press the number buttons to enter the channel number.
The channel number blinks. When the channel setting is complete, the blinking goes off.

- To enter a one-digit channel number, enter the number and press .

Note:

- When you insert a station, the station preset to PR99 is deleted.

■ Setting a station to a PR channel manually

If you want to set French stations to the PR channels:
You have to set the Country setting to FRANCE before setting French stations to the PR channels.
If your Country setting is not FRANCE, change the Country setting to FRANCE. To change the Country Setting, refer to "Changing the Country Setting" on page 26.

- Press ∇/\blacktriangle to choose a PR channel number, then press the blue button.

Note:

- PR channel number "AV" appears on the screen as PR 0 channel. We recommend setting this PR channel to the VCR RF channel from a VCR connected to the aerial socket.

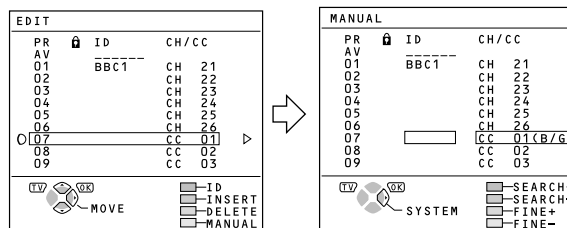

- Press the green or red button to search for a station.
Scanning stops when the TV finds a station.
To continue searching, press the red or green button again and repeat until the station you want appears.

If reception is poor:
Press the blue or yellow button to fine-tune the station.

If reception is not correct:
Press \blacktriangleright to choose the correct broadcast system.

When your COUNTRY setting is FRANCE:
If the broadcast system is not set correctly, you may be unable to find the station you want to view. At such a time, press \blacktriangleright to select the correct broadcast system, then return to Step 2 and repeat it.

- Press .

Install

■ Using the ACI function

This TV has an ACI function which decodes the ACI (automatic Channel Installation) data. Using the ACI function allows all TV channels transmitted from the cable TV station to be properly registered quickly according to the data from the cable TV station.

Caution:

If your cable TV station broadcasts ACI data and if "ACI START/ACI SKIP" appears in the Auto Program menu, the ACI function is enabled. In all other cases, it is disabled.

- 1 Press **▼/▲** to choose **ACI START**. Then press **OK** to start the ACI function.

When you don't want to use the ACI function:

Press **▼/▲** to choose ACI SKIP and then press **OK**.

If the Auto Program menu changes to another menu:

Depending on your cable TV station, there may be a broadcast selection menu set up by the cable TV station.

Follow the menu indications and use the **◀/▶** and **▼/▲** buttons to operate the menu. After you have made the setting, press **OK**.

If "ACI ERROR" is displayed in the Auto Program menu:

"ACI ERROR" denotes that the ACI function is not working properly. Press **OK** to start the ACI function again. If "ACI ERROR" still appears even after you have tried to start the ACI function several times, press **▶** to start the Auto Program function. It does not cause any problem because all the TV channels are registered to the PR channels by the Auto Program function.

- 2 When the settings are completed, the **Edit** menu is displayed. Return to the instructions that you were reading before, and continue the operation.

When the "Initial setting" has been made:

Return to step 7 of "Initial setting" on page 4.

When the "Auto Program" has been made:

Return to step 4 of "Auto Program" on page 23.

Notes:

- If you have any questions about the items in the Broadcast Selection menu or how to operate the menu, please contact your cable TV station.
- When the cable TV broadcast reception is poor, the ACI function will not work properly.
- If there is an error in the ACI data itself, the TV channel can not be registered properly. If this happens, turn the ACI function off (ACI SKIP) and use the Auto Program function. Alternatively, use the Edit/Manual function to correct the PR channel setting.

■ Downloading the PR channel data to the VCR.

You can transmit the latest PR channel data from the TV to the VCR with T-V LINK.

- 1 Make sure that the **T-V LINK** menu is displayed.

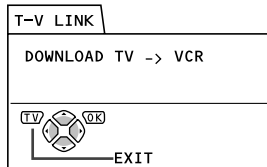

Notes:

- You cannot display the T-V LINK menu directly by choosing it from a menu.
- You cannot transmit the PR channel data to the VCR when a T-V LINK compatible VCR is not connected. Press **TV** to exit the menu.
- For details about T-V LINK, refer to page 5.

- 2 Turn the VCR on.

- 3 Press **OK**.

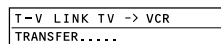

The data transmission begins.

The display disappears once the data transmission ends.

Note:

- Depending on the type of VCR, the display may change once data transmission ends. In this case, refer to the VCR's manual.

■ Changing the Country Setting

- 1 Display the Install menu.

- To return to the Install menu from the Edit menu, press **i** (information).

- 2 Press **▼/▲** to choose **AUTO PROGRAM**. Then press **OK**.

The Country menu appears.

- 3 Press **◀/▶/▼/▲** to choose a Country. This completes the setting.

- 4 Press **OK** to exit the MENU.

- To return to the Install menu, press **i** (information).

Index

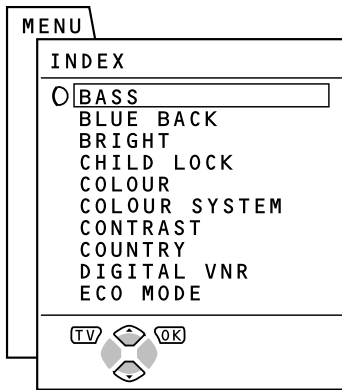

1 Display MENU.



2 Choose INDEX.



3 Display the Index menu.



The functions in each menu are listed in the Index menu. The required function can be found in the Index menu and the operating menu for that function can be entered with one touch.

1 Press ▼/▲ to choose a function.
If the desired function is not displayed, press ▼/▲ until it appears.

2 Press .
The chosen function's operating menu will be displayed.

Demo

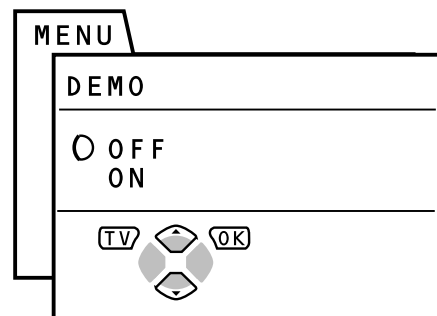

1 Display MENU.



2 Choose DEMO.



3 Display the Demo menu.



You can see the main features of your TV by using the Demo function.

When the Demo is set to ON:

Each time the TV is turned on, the demonstration starts automatically. If you do not want that to happen, set the Demo setting to OFF.

1 Press ▼/▲ to choose ON.
• To cancel the Demo function, choose OFF.

2 Press .
The demonstration will start.

To stop the demonstration, press one of the buttons on the remote control.

Additional Preparation

Notes:

- Use headphones with a stereo mini jack (dia. 3.5 mm). When using headphones, the speakers will not output sound.
- For further details, refer to manuals provided with the devices you are connecting.
- Connecting cables are not supplied.
- This TV set has external device connectors to which you can connect external devices. However, there are some differences in functions among them. Consult the table below before making connections.

- ① VCR (composite signal)
- ② VCR (composite signal/ S-VIDEO signal)
- ③ T-V LINK compatible VCR (composite signal/ S-VIDEO signal)
- ④ Decoder
- ⑤ DVD player (composite signal/ S-VIDEO signal)
- ⑥ DVD player (composite signal/ RGB signal)
- ⑦ TV game (composite signal/ RGB signal)
- ⑧ TV game (composite signal/ S-VIDEO signal)
- ⑨ Headphones
- ⑩ Camcorder (composite signal/ S-VIDEO signal)
- ⑪ SCART cable
- ⑫ Audio cable
- ⑬ Video cable
- ⑭ S-VIDEO cable

External terminals specifications

	EXT-1	EXT-2	EXT-3	EXT-4
VIDEO IN	√	√*1	√*1	√*1
VIDEO OUT	√*2	√*3	—	—
S-VIDEO IN	—	√*1	√*1	√*1
S-VIDEO OUT	—	—	—	—
RGB IN	√	—	—	—
AUDIO-L IN	√	√	√	√
AUDIO-R IN	√	√	√	√
AUDIO-L OUT	√*2	√*3	—	—
AUDIO-R OUT	√*2	√*3	—	—
T-V LINK	—	√	—	—
Others	<ul style="list-style-type: none"> • Automatic detection and switching of input mode. • Automatic detection and switching of ZOOM mode. 			

*1 Choose VIDEO or S-VIDEO mode from the EXT Setting menu. For details, see page 20 "EXT Setting".

*2 Only the TV broadcast is output.

*3 TV broadcasts or inputs from other EXT terminals can be output. For details, see page 20 "Dubbing".

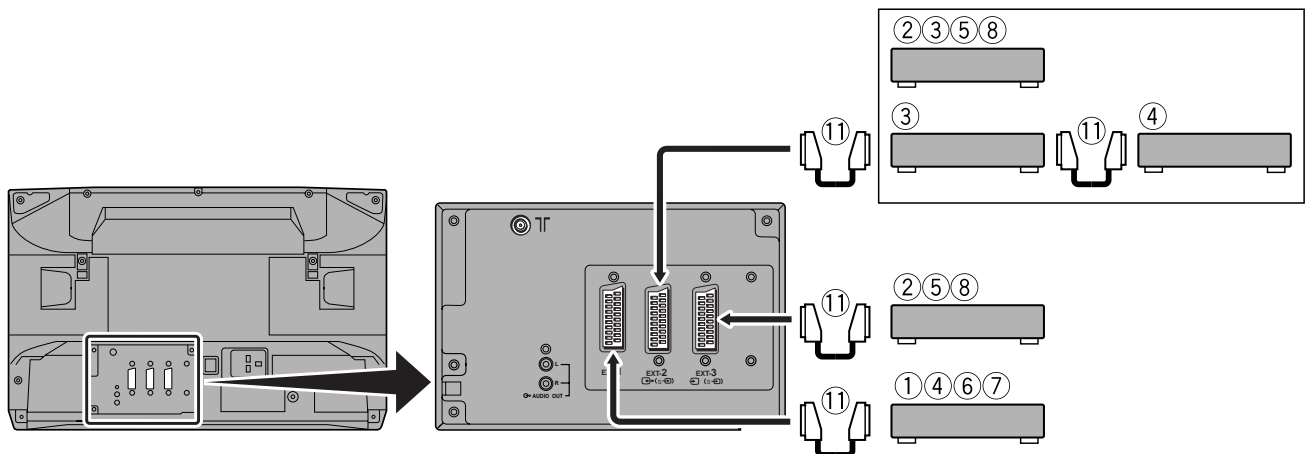
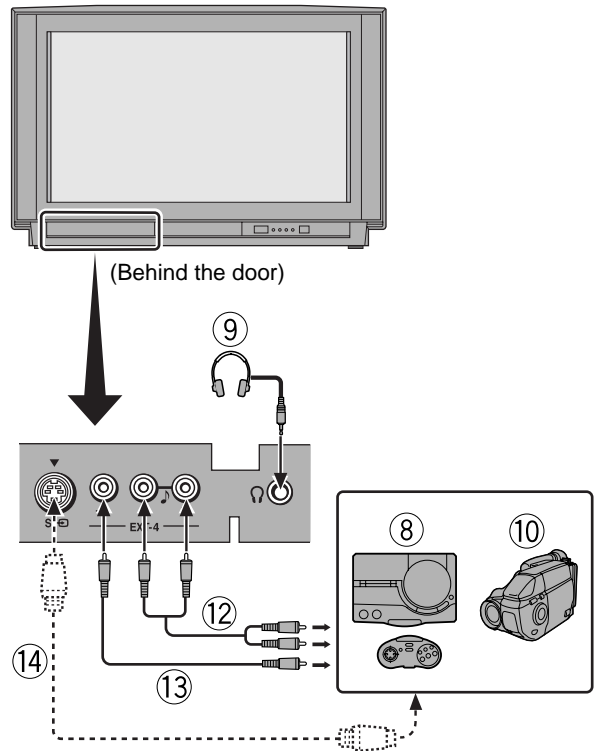

Connecting an Audio System

You can use your audio system as front speakers instead of the front speakers on the TV.

Caution:

Do the following before connecting,

- Turn the power of all the equipment off.
- Set the amplifier volume to low.
- Read the manuals provided with the amplifiers and speakers.

- 1 Stereo amplifier
2 Front speakers (Magnetic-shielded Type, L, R)

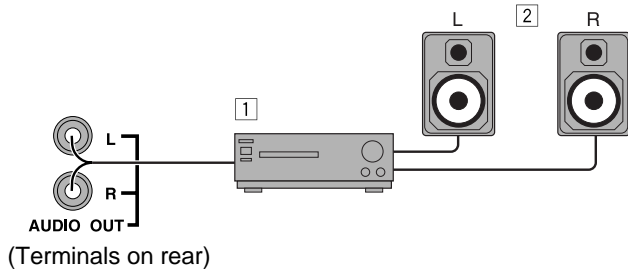

Notes:

- Use the AUDIO OUT terminals for connecting an audio system. The volume output is controlled via the TV and The AUDIO OUT terminal output is not interrupted by headphone connection.
- Use magnetic-shielded speakers for front speakers 2 to prevent interference by the TV.

- 1 Connect your stereo amplifier 1 to the AUDIO OUT terminals.
- 2 Turn the TV on and set the volume to the lowest setting.
- 3 Press . The MENU appears.
- 4 Press / to choose SOUND SETTING. Then press .

The Sound Setting menu appears.

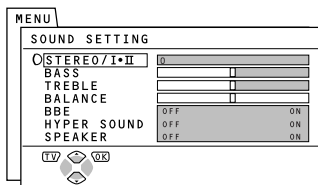

- 5 Press / to choose SPEAKER and press / to choose OFF.

To output sound from the TV speakers:
Set SPEAKER to ON.

- 6 Press .

This completes the settings.

- 7 Turn the stereo amplifier on and re-adjust the volume setting, then press / to adjust the volume.

Note:

- Setting the volume of the stereo amplifier too high may damage the speakers.

Channel Table

- The following table shows the relationship between the displayed CH/CC channel number and the actual channel number.
- The actual channel numbers for the “CC” channel numbers from CC110 to CC161 differ depending on the cable TV station. Check which actual channel numbers correspond to which “CC” channels while referring to the broadcast frequencies which are indicated in the channel tables of each cable TV station. If you cannot find the broadcast frequency for a channel, contact the cable TV station.

CH	Channel	CH	Channel	CC	Channel	CC	Channel
CH 02 / CH 202	E2, R1	CH 40 / CH 240	E40, R40	CC 01 / CC 201	S1	CC 31 / CC 231	S31
CH 03 / CH 203	E3, ITALY A	CH 41 / CH 241	E41, R41	CC 02 / CC 202	S2	CC 32 / CC 232	S32
CH 04 / CH 204	E4, ITALY B, R2	CH 42 / CH 242	E42, R42	CC 03 / CC 203	S3	CC 33 / CC 233	S33
CH 05 / CH 205	E5, ITALY D, R6	CH 43 / CH 243	E43, R43	CC 04 / CC 204	S4	CC 34 / CC 234	S34
CH 06 / CH 206	E6, ITALY E, R7	CH 44 / CH 244	E44, R44	CC 05 / CC 205	S5	CC 35 / CC 235	S35
CH 07 / CH 207	E7, ITALY F, R8	CH 45 / CH 245	E45, R45	CC 06 / CC 206	S6	CC 36 / CC 236	S36
CH 08 / CH 208	E8, R9	CH 46 / CH 246	E46, R46	CC 07 / CC 207	S7	CC 37 / CC 237	S37
CH 09 / CH 209	E9, ITALY G	CH 47 / CH 247	E47, R47	CC 08 / CC 208	S8	CC 38 / CC 238	S38
CH 10 / CH 210	E10, ITALY H, R10	CH 48 / CH 248	E48, R48	CC 09 / CC 209	S9	CC 39 / CC 239	S39
CH 11 / CH 211	E11, ITALY H+1, R11	CH 49 / CH 249	E49, R49	CC 10 / CC 210	S10	CC 40 / CC 240	S40
CH 12 / CH 212	E12, ITALY H+2, R12	CH 50 / CH 250	E50, R50	CC 11 / CC 211	S11	CC 41 / CC 241	S41
CH 21 / CH 221	E21, R21	CH 51 / CH 251	E51, R51	CC 12 / CC 212	S12	CC 75 / CC 275	X
CH 22 / CH 222	E22, R22	CH 52 / CH 252	E52, R52	CC 13 / CC 213	S13	CC 76 / CC 276	Y, R3
CH 23 / CH 223	E23, R23	CH 53 / CH 253	E53, R53	CC 14 / CC 214	S14	CC 77 / CC 277	Z, ITALY C, R4
CH 24 / CH 224	E24, R24	CH 54 / CH 254	E54, R54	CC 15 / CC 215	S15	CC 78 / CC 278	Z+1, R5
CH 25 / CH 225	E25, R25	CH 55 / CH 255	E55, R55	CC 16 / CC 216	S16	CC 79 / CC 279	Z+2
CH 26 / CH 226	E26, R26	CH 56 / CH 256	E56, R56	CC 17 / CC 217	S17		
CH 27 / CH 227	E27, R27	CH 57 / CH 257	E57, R57	CC 18 / CC 218	S18		
CH 28 / CH 228	E28, R28	CH 58 / CH 258	E58, R58	CC 19 / CC 219	S19		
CH 29 / CH 229	E29, R29	CH 59 / CH 259	E59, R59	CC 20 / CC 220	S20		
CH 30 / CH 230	E30, R30	CH 60 / CH 260	E60, R60	CC 21 / CC 221	S21		
CH 31 / CH 231	E31, R31	CH 61 / CH 261	E61, R61	CC 22 / CC 222	S22		
CH 32 / CH 232	E32, R32	CH 62 / CH 262	E62, R62	CC 23 / CC 223	S23		
CH 33 / CH 233	E33, R33	CH 63 / CH 263	E63, R63	CC 24 / CC 224	S24		
CH 34 / CH 234	E34, R34	CH 64 / CH 264	E64, R64	CC 25 / CC 225	S25		
CH 35 / CH 235	E35, R35	CH 65 / CH 265	E65, R65	CC 26 / CC 226	S26		
CH 36 / CH 236	E36, R36	CH 66 / CH 266	E66, R66	CC 27 / CC 227	S27		
CH 37 / CH 237	E37, R37	CH 67 / CH 267	E67, R67	CC 28 / CC 228	S28		
CH 38 / CH 238	E38, R38	CH 68 / CH 268	E68, R68	CC 29 / CC 229	S29		
CH 39 / CH 239	E39, R39	CH 69 / CH 269	E69, R69	CC 30 / CC 230	S30		

CH	Channel	CH	Channel	CC	Frequency (MHz)	CC	Frequency (MHz)
CH 102	F2	CH 141	F41	CC 110	116 - 124	CC 151	383 - 391
CH 103	F3	CH 142	F42	CC 111	124 - 132	CC 152	391 - 399
CH 104	F4	CH 143	F43	CC 112	132 - 140	CC 153	399 - 407
CH 105	F5	CH 144	F44	CC 113	140 - 148	CC 154	407 - 415
CH 106	F6	CH 145	F45	CC 114	148 - 156	CC 155	415 - 423
CH 107	F7	CH 146	F46	CC 115	156 - 164	CC 156	423 - 431
CH 108	F8	CH 147	F47	CC 116	164 - 172	CC 157	431 - 439
CH 109	F9	CH 148	F48	CC 123	220 - 228	CC 158	439 - 447
CH 110	F10	CH 149	F49	CC 124	228 - 236	CC 159	447 - 455
CH 121	F21	CH 150	F50	CC 125	236 - 244	CC 160	455 - 463
CH 122	F22	CH 151	F51	CC 126	244 - 252	CC 161	463 - 469
CH 123	F23	CH 152	F52	CC 127	252 - 260		
CH 124	F24	CH 153	F53	CC 128	260 - 268		
CH 125	F25	CH 154	F54	CC 129	268 - 276		
CH 126	F26	CH 155	F55	CC 130	276 - 284		
CH 127	F27	CH 156	F56	CC 131	284 - 292		
CH 128	F28	CH 157	F57	CC 132	292 - 300		
CH 129	F29	CH 158	F58	CC 133	300 - 306		
CH 130	F30	CH 159	F59	CC 141	306 - 311		
CH 131	F31	CH 160	F60	CC 142	311 - 319		
CH 132	F32	CH 161	F61	CC 143	319 - 327		
CH 133	F33	CH 162	F62	CC 144	327 - 335		
CH 134	F34	CH 163	F63	CC 145	335 - 343		
CH 135	F35	CH 164	F64	CC 146	343 - 351		
CH 136	F36	CH 165	F65	CC 147	351 - 359		
CH 137	F37	CH 166	F66	CC 148	359 - 367		
CH 138	F38	CH 167	F67	CC 149	367 - 375		
CH 139	F39	CH 168	F68	CC 150	375 - 383		
CH 140	F40	CH 169	F69				

TV Buttons and Parts

Front Panel

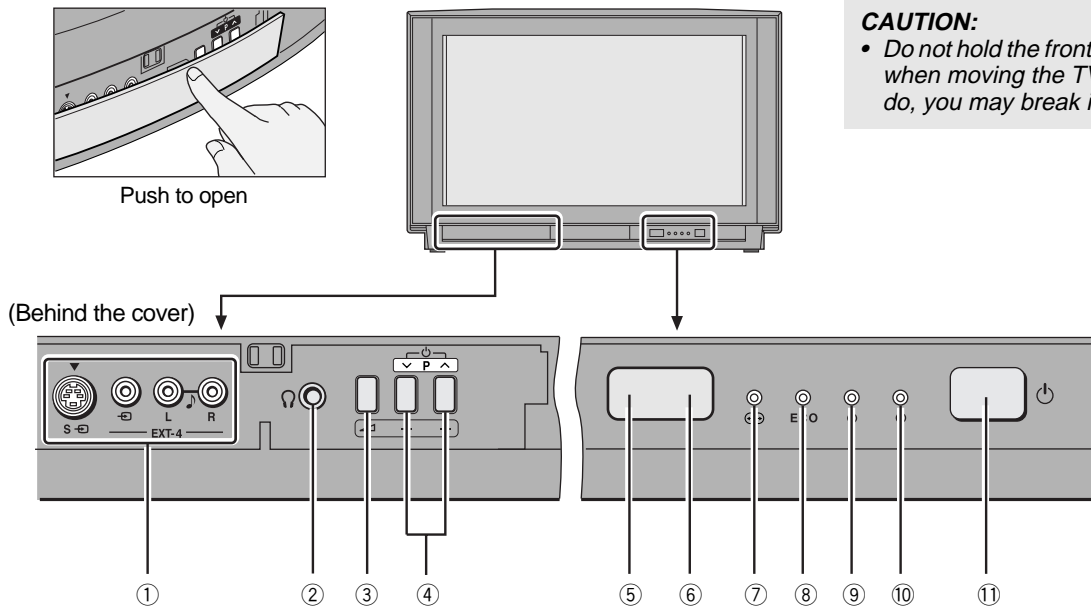

CAUTION:
 • Do not hold the front panel cover when moving the TV set. If you do, you may break it.

① EXT-4 terminals	pages 20, 28
② Headphone jack (mini jack)	page 28
③ ∇ (Volume) button	page 7
④ P ∇/\wedge buttons / ∇ -/+ buttons	page 7
⑤ Remote control sensor	
⑥ ECO sensor	

⑦ Hyper Sound lamp	pages 10, 18
⑧ ECO lamp	page 15
⑨ Sleep timer lamp	page 21
⑩ Power lamp	pages 3, 6
⑪ Main power button	pages 3, 6

Rear Panel

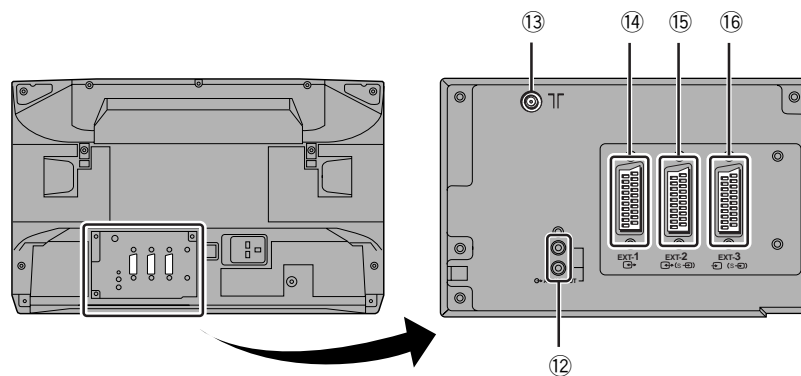

⑫ AUDIO OUT terminal	page 29
⑬ Aerial socket	page 2
⑭ EXT-1 terminal	pages 2, 20, 28

⑮ EXT-2 terminal	pages 2, 5, 20, 28
⑯ EXT-3 terminal	pages 20, 28

Troubleshooting

- If the plug is disconnected from the AC socket, or the TV aerial has problems, you may think there is a problem with the TV itself. Be sure to check the following before calling for service.

IMPORTANT

- Review all instructions in this manual

	Problem	Action
■ GENERAL	The TV cannot be turned on.	<ul style="list-style-type: none"> • Insert the plug in an AC socket. • Turn the main power on. (See page 6.)
	No picture or sound.	<ul style="list-style-type: none"> • Check aerial connections. (See page 2.) • Choose the correct input mode. (See page 7.) • Choose the correct colour system manually. (See page 17.)
	The TV shuts off automatically.	<ul style="list-style-type: none"> • Did you set the Sleep Timer? (See page 21.)
	Inoperable remote control.	<ul style="list-style-type: none"> • Replace the batteries. (See page 2.) • Insert the batteries correctly. (See page 2.) • Use the remote control within about 7 metres of the TV.
	MENU cannot be displayed.	<ul style="list-style-type: none"> • Are you watching the Teletext screen? None of the Menu operations are possible when viewing a teletext programme. Perform the Menu operation in the TV mode.
	■ PICTURE	Poor colour.
The ZOOM mode suddenly changes.		<ul style="list-style-type: none"> • The AUTO mode is working. (See page 9.)
The picture is tilted .		<ul style="list-style-type: none"> • Correct the tilted picture. (See page 17.)
Lines or streaks in picture (interference).		<ul style="list-style-type: none"> • Move the components apart until the interference is eliminated. • Reposition the aerial.
Spots (crosstalk).		<ul style="list-style-type: none"> • Reposition the aerial. • Replace with an aerial with better directionality.
Double pictures (ghosts).		<ul style="list-style-type: none"> • Reposition the aerial. • Replace with an aerial with better directionality.
Snowy pictures (noise).		<ul style="list-style-type: none"> • Check aerial connections. • Redirect the aerial. • Replace or repair the aerial.
The screen turns blue.		<ul style="list-style-type: none"> • Is the Blue Back function set to ON? (See page 21.)
■ SOUND	No sound from the TV's speakers.	<ul style="list-style-type: none"> • Disconnect the headphones. • Set SPEAKER to ON. (See page 19.)
	No stereo sound.	<ul style="list-style-type: none"> • Change STEREO/I•II to ∞ mode. (See page 18.)
	No "SUB-I" or "SUB-II" sound in a multi-sound broadcast.	<ul style="list-style-type: none"> • Change STEREO/I•II to the correct mode. (See page 18.)
■ TELETEXT	No teletext reception.	<ul style="list-style-type: none"> • Tune to a channel that has teletext. (See page 12.) • Videotaping teletext is not recommended as it may not record correctly.
	The current time is not displayed.	<ul style="list-style-type: none"> • Tune to a channel that has teletext. (See page 12.)

The following are normal and are NOT malfunctions:

- When touching the picture tube surface, you might feel a slight charge of static electricity. This is because the picture tube contains static electricity; it does not affect the human body.
- The TV may emit a crackling sound due to a sudden change in temperature. There is no problem unless the picture or sound is abnormal.
- When a still, bright image (of a white dress, for example) appears on the screen, the image may be coloured. This problem occurs in all picture tubes, and as the bright image disappears, the colour also disappears.
- This TV is equipped with a microcomputer that may operate abnormally due to interference from external components. If this happens, turn off the main power and disconnect the power cord from the AC socket. Then reconnect the power cord to the AC socket and turn on the main power again.
- It takes a short period of time from the time an operation such as changing channels is performed until an image is displayed. This is not a malfunction. This is the time required for the image to stabilize before it can be displayed.
- When viewing images from commercially available video software products, or videos from videotapes which have been recorded improperly, the top of the image may be distorted. This is due to the condition of the video signal, and not because of malfunction.

Specifications

Item	Model	
	AV-32WFX1EU*	AV-28WFX1EU*
TV RF systems	CCIR B/G, I, D/K, L	
Colour systems	PAL, SECAM (NTSC 3.58 / 4.43 MHz only in EXT modes)	
Channels and frequencies	E2-E12, E21-E69, S1-S41, X, Y, Z, Z+1, Z+2, A-H, H+1, H+2, F2 – F10, F21 – F69, R1 – R12, R21 – R69 • French cable TV channel of broadcast frequencies 116 – 172 MHz and 220 – 469 MHz	
Sound-multiplex systems	A2 (B/G, D/K) / NICAM (B/G, D/K, L, I) system	
Teletext systems	FLOF (Fastext) / TOP / WST (standard system)	
Power requirements	AC 220 – 240 V, 50 Hz	
Power consumption	Maximum 195 W, Average 145 W, Standby 0.9 W	
Picture tube size	Visible area 76 cm (measured diagonally)	Visible area 66 cm (measured diagonally)
Audio output	Rated Power output: 7.5 W + 7.5 W	
Speakers	10 cm round × 2	(16 cm × 4cm) oval × 2
External input / output	EXT-1, EXT-2, EXT-3	21-pin Euroconnector (SCART)
	EXT-4	VIDEO IN (RCA) AUDIO L / R IN (RCA) S-VIDEO IN (Mini Din 4-pin)
	AUDIO OUT	(Variable out (0-1 Vrms), low impedance) FRONT L/R output (RCA)
	Headphone jack (stereo mini jack, dia. 3.5 mm)	
Dimensions (W × H × D)	855 mm × 550 mm × 568 mm	780 mm × 509 mm × 499 mm
Weight	57 kg	41 kg
Accessories	Remote control unit RM-C50 × 1 AAA (R03) dry cell battery × 2	

* A basic model number. The actual model number may have characters added (such as "S" denoting sliver) indicating the colour of the TV set.

Design and specifications subject to change without notice.

Pictures displayed on the screen using this TV's image-processing functions should not be shown for any commercial or demonstration purpose in public places (tearooms and halls in hotels, etc.) without the consent of the owners of copyright of the original picture sources, as this constitutes an infringement of copyright.

JVC
VICTOR COMPANY OF JAPAN, LIMITED